

Force

- » Peak: 344 - 860 N
- » Continuous: 52 - 119N

Maximum Velocity

- » Up to 5.6 m/s

Feedback

- » Built-in position sensor
- » 1V pk-pk sin/cos
- » 12 micron repeatability

Range of motion

- » 28~310 mm

Dimensions

- » W x H: 100 x 86mm
- » Rod diameter: 25mm

Applications

- » Packaging
- » Material Handling
- » Automated Assembly
- » Bio-medical

The OEM advantage

- » Ready-to-use actuator requires no bearing support
- » Flexible position control
- » High speed and acceleration
- » Clean, quiet operation
- » No maintenance or adjustment



The ServoTube Actuator high rigidity actuator with integrated outrigger-bearings is an ideal solution for applications with high side-loading. A ball-bushing option with steel bearing rails provides maximum side-loading support. Polymer bushings use aluminium rails for reduced weight and are ideal for vertical loads.

Iron-sleeve design produces up to 20% more force than standard ServoTube actuator. Four models deliver a continuous force range of 61~119N (14~27lb) with peak forces up to 860N (193lb). Twelve stroke lengths are available from 28~310mm.

The magnetic design of ServoTube generates 12 micron (0.47 mil) repeatability and 350 micron (14 mil) accuracy from a non-contact, integral position sensor. No external encoder is required. Position output is industry standard 1V pk-pk sin/cos signals.

ServoTube is an ideal OEM solution for easy integration into pick-and-place gantries and general purpose material handling machines. The load is mounted directly to the industry standard mounting plate.

ServoTube has superior thermal efficiency, radiating heat uniformly. High duty cycles are possible without the need for forced-air or water cooling.

ELECTRICAL SPECIFICATIONS

FORCER TYPE	2504	2506	2508	2510	units
Peak force @ 25°C ambient for 1 sec	344	516	688	860	N
Peak current @ 25°C ambient for 1 sec	20	20	20	20	Apk
With 25 x 25 x2.5cm heatsink plate					
Continuous stall force @ 25°C ambient ⁽¹⁾	60.7	81.8	101.2	119.4	N
Continuous stall current @ 25°C ambient	2.49	2.24	2.08	1.96	Arms
	3.53	3.17	2.94	2.78	Apk
Without heatsink plate					
Continuous stall force @ 25°C ambient ⁽¹⁾	52.2	72.3	90.4	108.0	N
Continuous stall current @ 25°C ambient	2.15	1.98	1.86	1.78	Arms
	3.03	2.80	2.63	2.51	Apk
Force constant (sine commutation)	24.3	36.5	48.6	60.8	N/Arms
	17.2	25.8	34.4	43.0	N/Apk
Back EMF constant (phase to phase)	19.9	29.8	39.7	49.7	Vpk/m/s
Fundamental forcer constant	7.53	9.22	10.65	11.90	N/√W
Eddy current loss	2.35	2.35	2.35	2.35	N/m/s
Sleeve cogging force	2.2	3.2	3.3	3.0	+/-N
Resistance @ 25°C (phase to phase)	5.40	8.11	10.81	13.51	Ohm
Resistance @ 100°C (phase to phase)	6.96	10.45	13.93	17.41	Ohm
Inductance @ 1kHz (phase to phase)	4.32	6.48	8.64	10.80	mH
Electrical time constant	0.80	0.80	0.80	0.80	ms
Maximum working voltage	380	380	380	380	V d.c.
Pole pitch (one electrical cycle)	51.2	51.2	51.2	51.2	mm
Peak acceleration ^(2,4)	225	288	334	369	m/s ²
Maximum speed ^(3,4)	5.6	5.3	4.8	4.3	m/s
Peak acceleration ^(2,5)	276	354	413	458	m/s ²
Maximum speed ^(3,5)	6.1	5.7	5.1	4.5	m/s

Notes:

- ⁽¹⁾ Reduce continuous stall force to 89% at 40°C ambient
⁽²⁾ Based on a moving thrust rod with 28mm stroke and no payload
⁽³⁾ Based on a moving thrust rod with triangular move over maximum stroke and no payload
⁽⁴⁾ -B bush bearing option
⁽⁵⁾ -P polymer bearing option

THERMAL SPECIFICATIONS

FORCER TYPE	2504	2506	2508	2510	units
Maximum phase temperature	100	100	100	100	°C
Thermal resistance Rth _{phase-housing}	0.39	0.28	0.23	0.19	°C/Watt
With 25 x 25 x2.5cm heatsink plate					
Power dissipation @ 25°C ambient	65.0	78.8	90.4	100.6	Watt
Thermal resistance Rth _{housing-ambient}	0.76	0.67	0.60	0.56	°C/Watt
Without heatsink plate					
Power dissipation @ 25°C ambient	48.1	61.5	72.1	82.4	Watt
Thermal resistance Rth _{housing-ambient}	1.17	0.94	0.81	0.72	°C/Watt
Thermal time constant	1639	1773	1940	2080	s

MECHANICAL SPECIFICATIONS

FORCER TYPE	2504	2506	2508	2510	units
Maximum stroke	310	310	310	310	mm
Forcer mass	1.65	2.25	2.85	3.45	kg
Moving mass (-B bush bearing option)	0.25+(overall length (m) x 5.24)				kg
Moving mass (-P polymer bearing option)	0.25+(overall length (m) x 4.10)				kg

MECHANICAL RIGIDITY

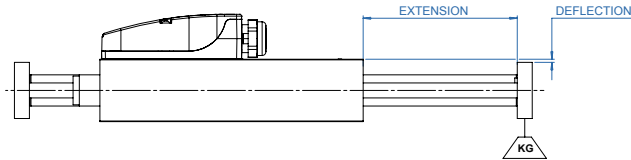

- 0kg
- 2kg
- 5kg
- 10kg

XTR2504 (-B bush bearing)

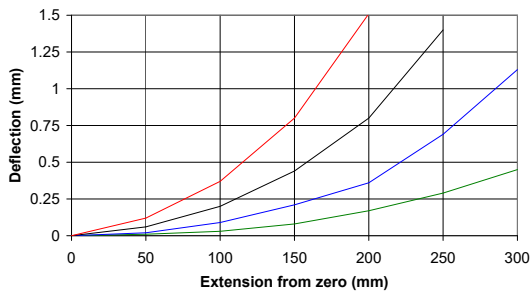

XTR2506 (-B bush bearing)

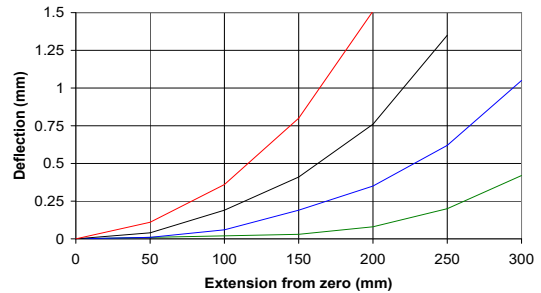

XTR2508 (-B bush bearing)

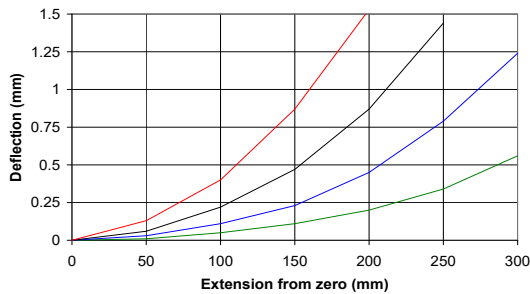

XTR2510 (-B bush bearing)

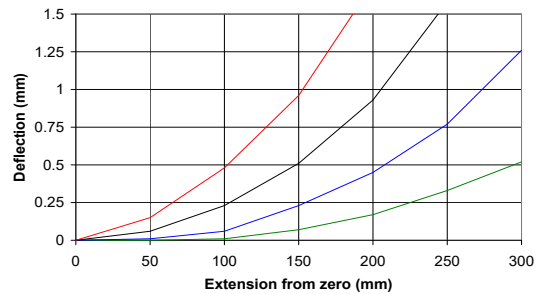

XTR2504 (-P polymer bearing)

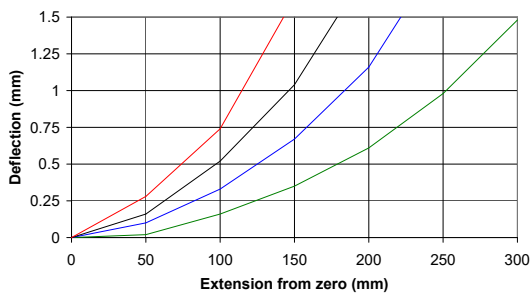

XTR2506 (-P polymer bearing)

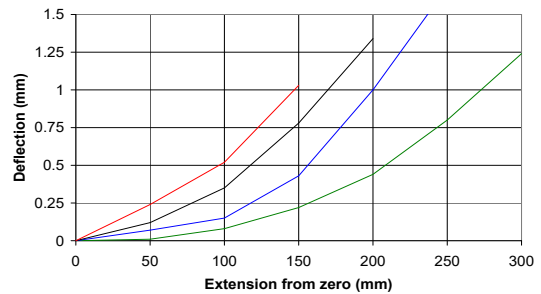

XTR2508 (-P polymer bearing)

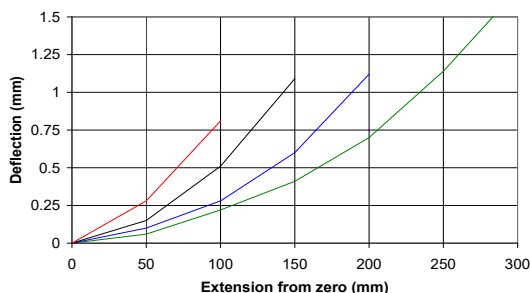

XTR2510 (-P polymer bearing)

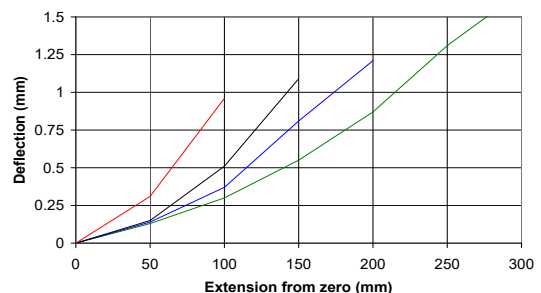

PAYLOAD VERSUS EXTENSION FOR 10.000KM LIFE

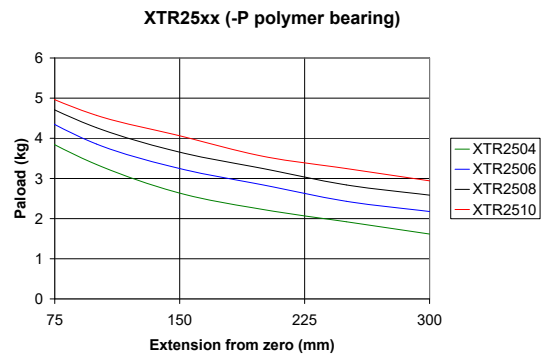
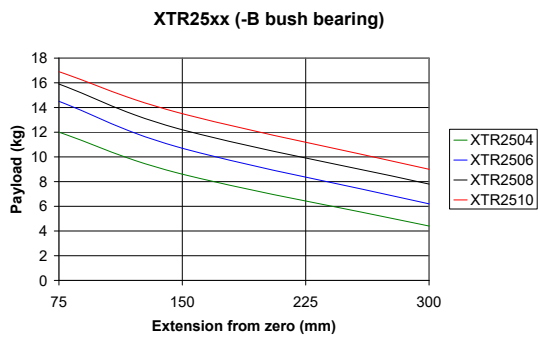

OUTLINE DRAWINGS

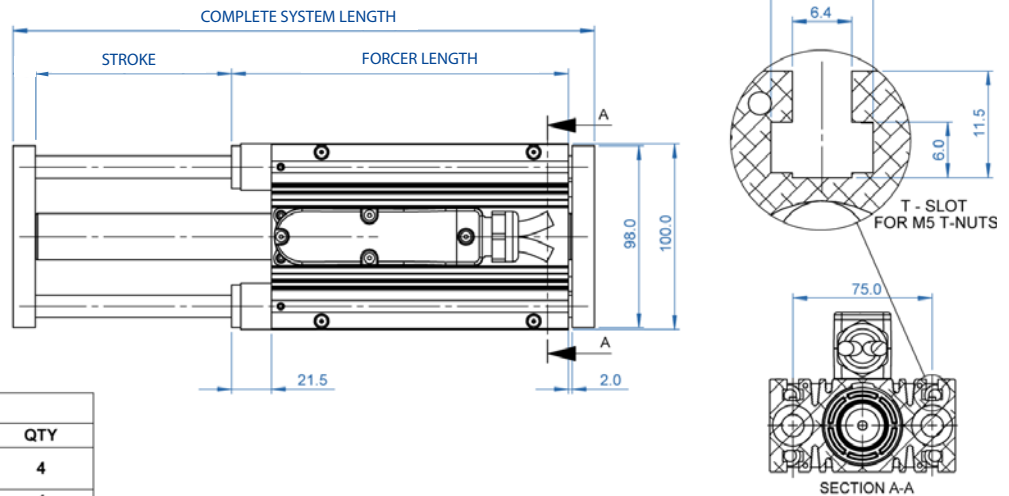

HOLE TABLE		
TAG	SIZE	QTY
A	C/B \varnothing 6.60 THRU \varnothing 11.0 ∇ 6.5	4
B	M6	4

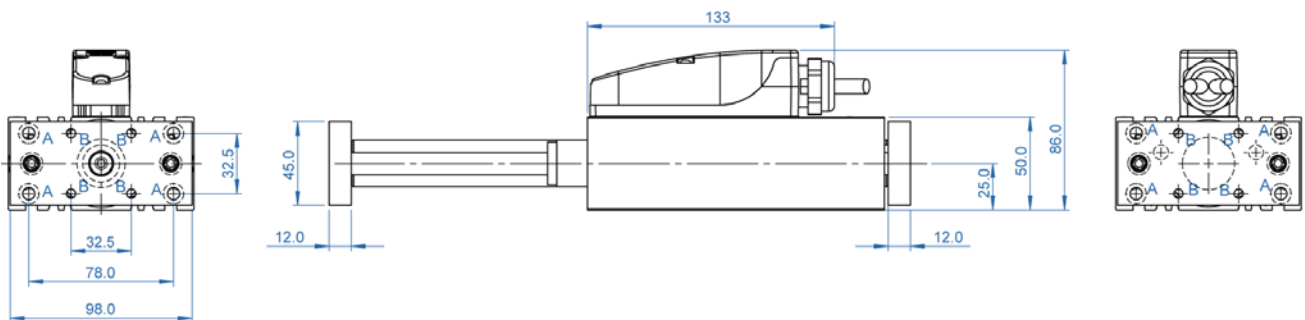

Stroke (mm)	Complete system length (mm)			
	XTR2504	XTR2506	XTR2508	XTR2510
28	236	287	339	390
54	262	313	364	415
79	287	339	390	441
105	313	364	415	467
131	339	390	441	492
156	364	415	467	518
182	390	441	492	544
207	415	467	518	569
233	441	492	544	595
259	467	518	569	621
284	492	544	595	646
310	518	568	621	672

	Forcer length (mm)
XTR2504	181,5
XTR2506	232,5
XTR2508	283,5
XTR2510	334,5

POSITION SENSOR

The position sensor outputs analogue, differential sine and cosine signals for providing position feedback. Shown below are the relationships between forcer phase back EMF and position sensor outputs for one direction of motion (as shown by arrows). It should be noted that +SIN or -SIN is always in phase with forcer phase U. For the motion shown, -SIN is in phase with forcer phase U. For motion in the opposing direction +SIN is in phase with forcer phase U.

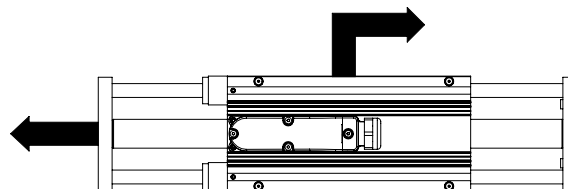
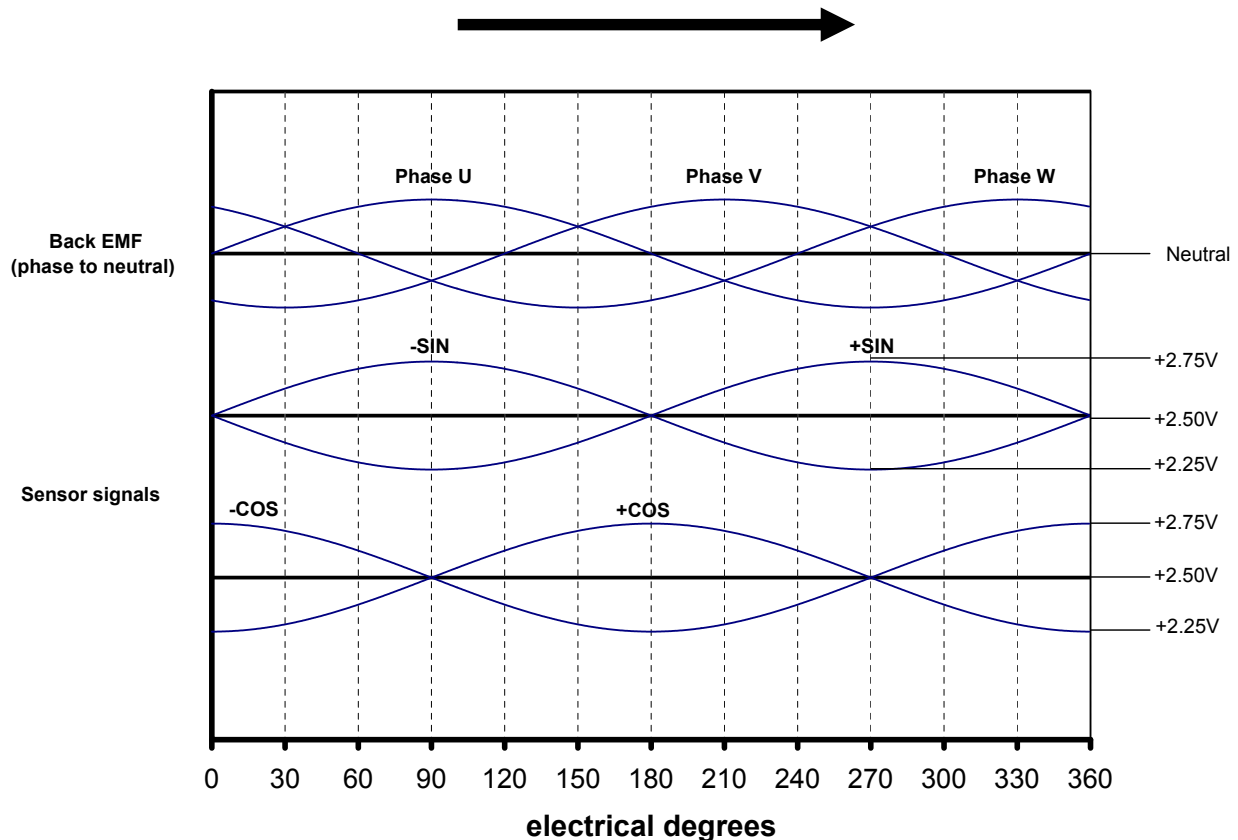

SPECIFICATION	VALUE	units
Output signal period	51.2	mm
Signal amplitude (between +/- signals)	1	Vpk-pk
Output current	± 10	mA
Supply voltage	5 ± 0.25	Vd.c.
Supply current (output current=0)	15 ± 5	mA
Resolution ⁽¹⁾	12	micron
Position repeatability ⁽²⁾	± 12	micron
Absolute accuracy ⁽³⁾	± 350	micron

Notes:

⁽¹⁾ Dependent on amplifier (indication with 12 bit resolution)

⁽²⁾ Dependent on amplifier. Under constant operating conditions. Self-heating of the forcer will cause expansion in the thrust rod during the initial warm up period. In high duty applications (corresponding to an internal forcer temperature of 80°C) a 1 metre thrust rod will expand typically by 250 microns.

⁽³⁾ Maximum error over 1 metre under constant operating conditions.

FORCER OVER TEMPERATURE SENSOR



It is strongly recommended that the forcer over-temperature sensor is connected to the drive amplifier or servo controller **at all times** in order to reduce the risk of damage to the forcer due to excessive temperatures.

Protection is provided by three positive temperature coefficient (PTC) thermistors embedded in the forcer phases. As the forcer phase temperature approaches 100°C, the PTC thermistors exhibits a sharp increase in electrical resistance. This change in resistance can be detected by circuitry within the drive amplifier or servo controller and used to reduce or disable the output of the drive amplifier in order to protect the forcer.

SPECIFICATION	VALUE	units
Resistance in the temperature range -20°C to + 70°C	60 to 750	Ohms
Resistance at 85°C	≤1650	Ohms
Resistance at 95°C	≥3990	Ohms
Resistance at 105°C	≥12000	Ohms
Maximum continuous voltage	30	Vd.c.

FORCER ELECTRICAL CONNECTIONS

Connections are made within the termination box.

PIN NUMBER	FUNCTION
1	Phase U
2	Phase V
3	Phase W
Chassis	Earth/Screen

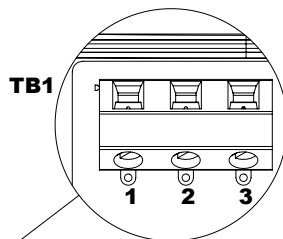

PIN NUMBER	FUNCTION
1	+SIN
2	-SIN
3	+COS
4	-COS
5	+5Vd.c.
6	0V
7	+TH (Thermistor)
8	-TH (Thermistor)

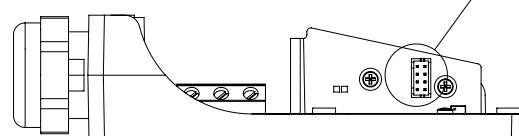
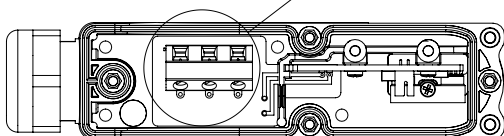
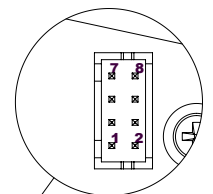

CABLE TYPE

The XTR has two separate cables providing connections for forcer power and position sensor. Cable types are available in 3 metre, 5 metre or 10 metre lengths.

Cables are suitable for continuous flex or drag chain applications.

	POWER	SENSOR
Overall diameter (nominal)	8.0mm	5.8mm
Outer jacket material	PUR	PUR
Number of conductors	4	4 x twisted pair
Size of conductors	1.5mm ² (22 AWG)	0.14mm ² (26AWG)
Screened / Unscreened	Screened	Screened
Minimum bending radius - flexible routing	42mm	42mm
Operating temperature - flexible routing	-15°C to +80°C	-15°C to +80°C
Operating temperature - fixed routing	-30°C to +80°C	-30°C to +80°C

CABLE TERMINATION

The XTR cable is available with three termination options. **Option F** has the wire ends stripped and solder tinned ready for termination. All other options are terminated with connectors that plug directly into the desired amplifier. The connections for all options are shown below: -

SENSOR FUNCTION	D - (XTL-S)	N - (ESR-Pollmeier)	F - (Flying leads)
+SIN	14	6	Blue
-SIN	13	7	Red
+COS	12	11	White
-COS	11	12	Brown
+5Vd.c.	4	10	Yellow
0V	5	15	Green
+TH (Thermistor)	10	5	Pink
-TH (Thermistor)	15	15	Grey
SCREEN	1+ shell	Shell	SCREEN
Connector type	15-way high density D	15-way high density D	-
Amplifier connection	J8	X6.2	-
POWER FUNCTION			
Forcer phase U	4	U	Black <u>1</u>
Forcer phase V	3	V	Black <u>2</u>
Forcer phase W	2	W	Black <u>3</u>
Earth (forcer body)	1	PE	Green/Yellow
SCREEN	1	Shell	SCREEN
Connector type	4-way 5mm pluggable terminal	4-way pluggable terminal	-
Amplifier connection	J2	X3	-

BRAKE INFORMATION (OPTIONAL)

When selecting the brake, the stroke is reduced by 60 mm.

ENVIRONMENT

The XTR is intended for use in an environment within the following conditions:

SPECIFICATION	VALUE
Operating temperature	0°C to +40°C
Storage temperature	-25°C to +70°C
Ingress protection	IP67
Altitude (above mean sea level)	1000m
Overvoltage category	II
Pollution degree	2
EMC	light industrial

In addition, the XTR is available with two environmental coating options. The forcer body is coated as standard with a 25 micron layer of black anodise that is suitable for general use. **Option H** has the forcer body coated with a 90 micron layer of hard natural anodise that is suitable for harsher environments. This option is available at a minimum quantity of 25 pieces per year.

ORDER CODES

Actuator

XTR25 □ □ □ - □ □ □ □ - □ - □ □ □ □ - □ □

Forcer

04, 06, 08, 10

Winding

S - Series

Stroke

028, 054, 079, 105, 131, 156
182, 207, 233, 259, 284, 310

Stroke in mm

Bearing

B - Bush
P - Polymer

Environment

S - Standard
H - Harsh (on request)

Brake

blank - no brake
BR - Brake

Cable Termination

D - Xenus (XTL-S)
F - Flying leads
N - ESR Pollmeier

Cable Length

03 - 3 m
05 - 5 m
10 - 10 m

Cable Type

R - Robotic

Features

- » Vertical Holding Brake
- » Holding Force > 200N
- » 24 Volt DC supply
- » Fail Safe Operation



The OEM advantage

- » High holding force in small package
- » Reliable and cost-effective
- » No maintenance or adjustment

OVERVIEW

The ServoTube brake provides a solution to power down parking of vertical axes and controlled deceleration of axes during power fail conditions. The brake is a bolt-on addition to any XTR25 forcer and is IP67 rated. It is a unidirectional self-jamming design, which uses the motor's motion to create the necessary forces for braking the system. To minimize size, the brake is designed to be reset by the motor itself. Once reset, it is held off by a compact 24V electromagnet. The motor is then free to operate as normal until the release of power to the brake.

OPERATION

From power-on, the brake must be released before normal operation of the motor.

Release:

1. Apply power to the forcer and drive the thrust rod UP by applying sufficient force to overcome the braking action (70-80N).
2. Continue driving UP until the STOP on the thrust rod activates the BRAKE RELEASE. Activation can be detected by the controller when velocity=0 or there is no change in position.
3. Apply 24V to brake solenoid.
4. Wait 100ms.
5. The brake will now hold off and the forcer can operate as normal.

Activate:

1. Remove 24V from the brake solenoid. The thrust rod will fall a very short distance before the brake activates.
2. Wait 100ms.
3. Disable the servo to remove power from the forcer.

SPECIFICATIONS

Angabe	Wert
Environment	
Operating temperature	0°C ... +40°C
Humidity (relative)	0 ... 95% (non-condensing)
Electrical data	
Power requirement	24VDC +/- 10%
Power dissipation	4 W
Brake	
Holding force	>200 N
Reset force (using motor)	50 ... 70 N
Mass	0,26 kg

OUTLINE DRAWINGS

SBR25

